

**MELAMINE LAMINATED CHIPBOARD SURFACE COLOUR**

**BOARD COLOUR OPTION**



WHITE



GREY



BEECH



CHERRY

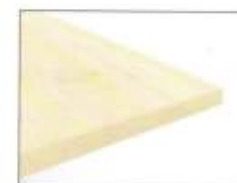

MAPLE



ELMER



THUJA LIGHT



CAPPUCCINO

\* Price higher

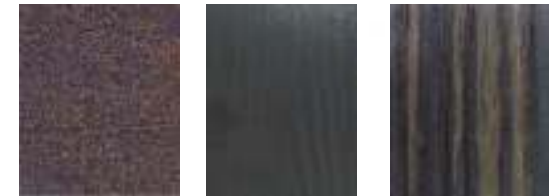

WALNUT / WENGE / MAKASSAR

**METAL LEG COLOUR OPTION**



J CANTILEVER LEG



INULA A LEG



MATRIX SQUARE LEG



MATRIX U LEG

WHITE  
SILVER  
DARK GREY

•**Actual Colour may vary \* Kindly refer to Actual Sample board**  
•**\* Subject to availability**



(SA 0091847-K)  
T : 016-260 3208 / 016-337 6818  
F : 03-5634 8332 / 03-8062 1098  
W : www.despaceoffice.com

**This Drawing is Copyrighted.**

**PARTITION FRAME COLOUR OPTION**

**MATRIX SYSTEM 45mm THK**



WHITE



SILVER



DARK GREY

**MATRIX SYSTEM 54mm THK**



GREY



BLACK

**MATRIX SYSTEM 60mm THK**



DARK GREY



SILVER

**MATRIX SYSTEM 80mm THK**



DARK GREY



GREY

**MATRIX SYSTEM 20mm THK**



WHITE



SILVER

**60MM POLE SYSTEM**



DARK GREY

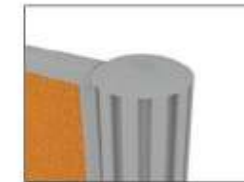

SILVER

**Partition Frame Color**

**DE SPACE**  
OFFICE SYSTEM  
(SA 0091847-K)  
T : 016-260 3208 / 016-337 6818  
F : 03-5634 8332 / 03-8062 1098  
W : www.despaceoffice.com  
**This Drawing is Copyrighted.**

# Metal Leg Type

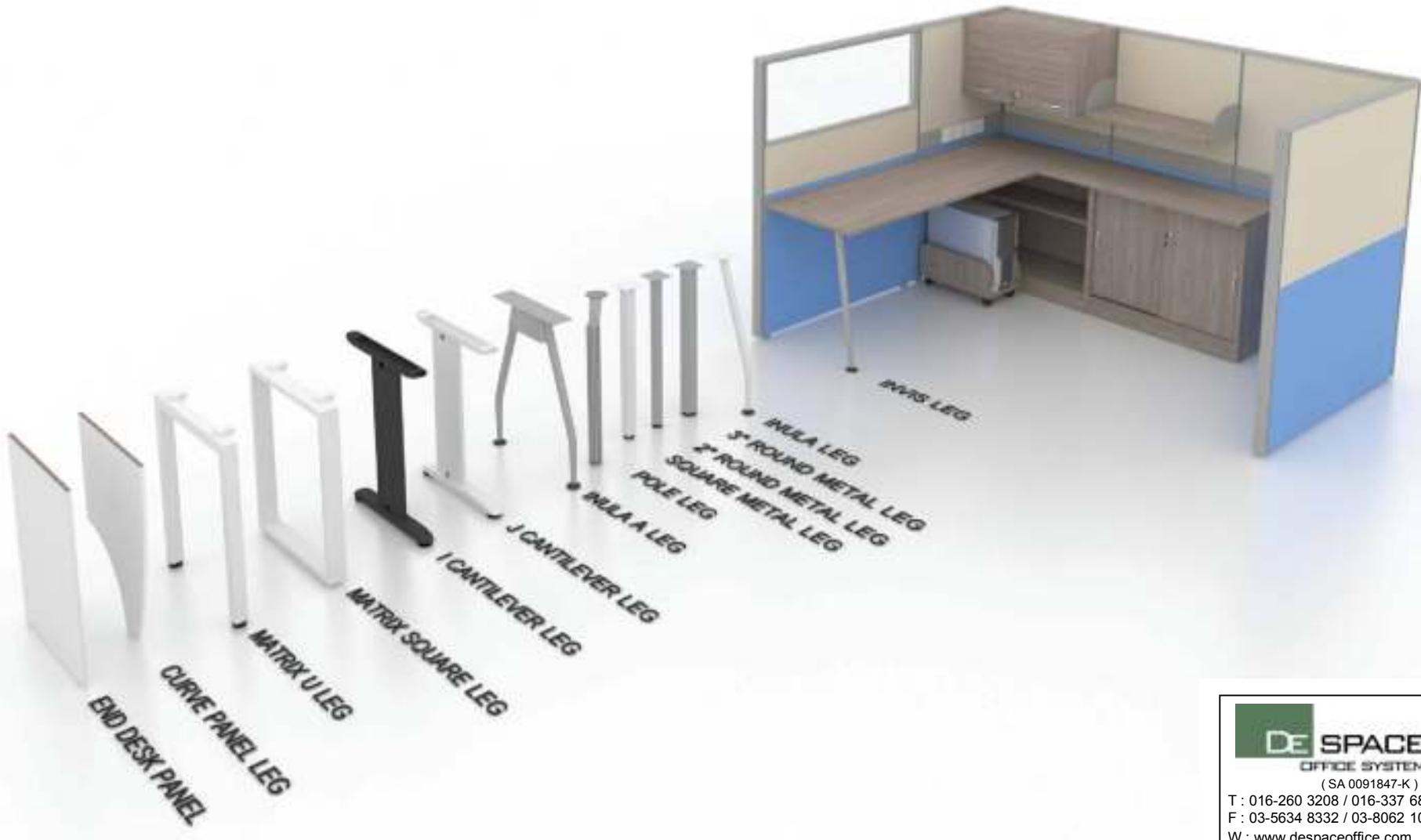

T : 016-260 3208 / 016-337 6818  
F : 03-5634 8332 / 03-8062 1098  
W : www.despaceoffice.com

This Drawing is Copyrighted.

**Office Furniture ( Meeting Table )**

**\* OPTIONAL ITEMS**

RECESS CONSOLE



FLIPPER WIRE BOX



CHIPBOARD FLIPPER



CHIPBOARD  
FLIPPER BOX



WIRE HOLDER



WIRE MANAGEMENT



T : 016-260 3208 / 016-337 6818  
F : 03-5634 8332 / 03-8062 1098  
W : [www.despaceoffice.com](http://www.despaceoffice.com)

**This Drawing is Copyrighted.**

**Office Furniture ( Meeting Table )**

**\* OPTIONAL ITEMS**



**Wire holder** ( Silver colour )



**Flipper Cover + WireBox ( for wire socket ) ( \* Silver )**

\* Electrical works / Wire socket / Points by others



( SA 0091847-K )

T : 016-260 3208 / 016-337 6818

F : 03-5634 8332 / 03-8062 1098

W : www.despaceoffice.com

**This Drawing is Copyrighted.**

**Office Furniture ( Meeting Table )**

**\* OPTIONAL ITEMS**



**WIRE HOLDER**

Wire holder ( Silver colour )

\*

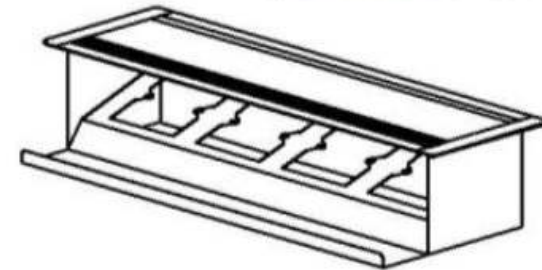

TOP OPENING SIZE : 425 X 115

**FLIPPER WIRE BOX  
( 4 HOLE )**

Flipper Cover + WireBox ( for wire socket ) ( \* Silver )

\* Electrical works / Wire socket / Points by others

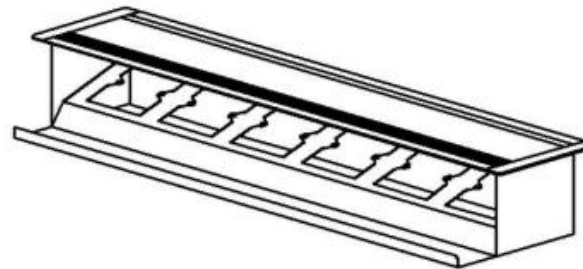

Flipper Wire Box ( 6 holes )  
( Top opening 625 x 115 )



( SA 0091847-K )

T : 016-260 3208 / 016-337 6818

F : 03-5634 8332 / 03-8062 1098

W : www.despaceoffice.com

This Drawing is Copyrighted.

**Office Furniture ( Meeting Table )**

**\* OPTIONAL ITEMS**

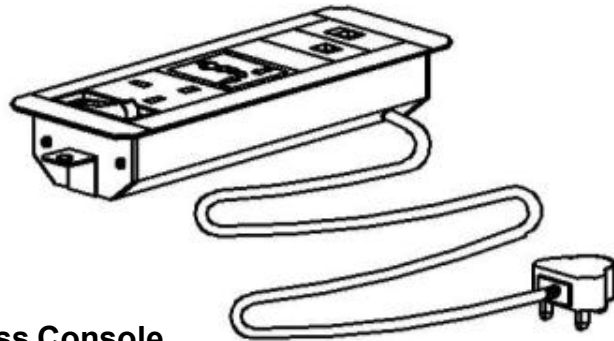

**Recess Console**

POWER SOCKET x 1 + UNIVERSAL SOCKET x 1  
+ TEL POINT x 1 + LAN POINT x 1

\* Electrical works / Wire socket / Points by others

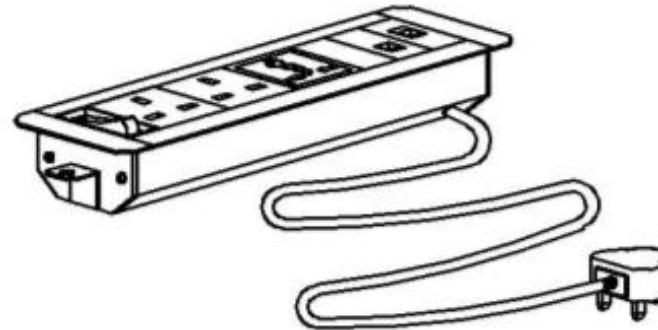

**Recess Console**

POWER SOCKET x 2 + UNIVERSAL SOCKET x 1  
+ TEL POINT x 1 + LAN POINT x 1

\* Electrical works / Wire socket / Points by others

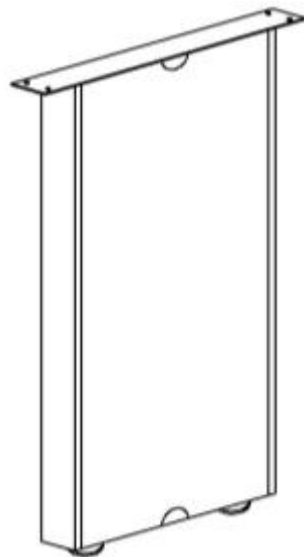

**WIRE MANAGEMENT ( Metal )**  
( 300W x 50D x 725H ) mm



**Flipper cover ( for 4 holes & 6 holes )**

( Top opening : 425 & 625 x 115 )

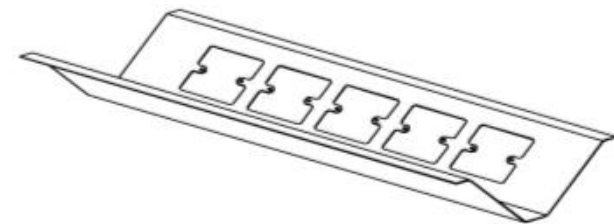

**Horizontal wire trunking**

1200L , 1500L , 1800L

\* Electrical works / Wire socket / Points by others



( SA 0091847-K )

T : 016-260 3208 / 016-337 6818

F : 03-5634 8332 / 03-8062 1098

W : www.despaceoffice.com

**This Drawing is Copyrighted.**

**Office Furniture ( Meeting Table )**

**\* OPTIONAL ITEMS**

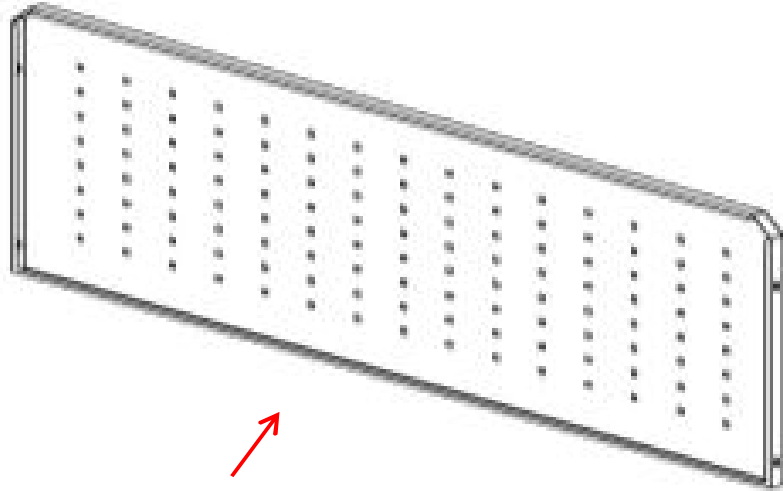

**Perforated Modesty Panel ( Metal )**

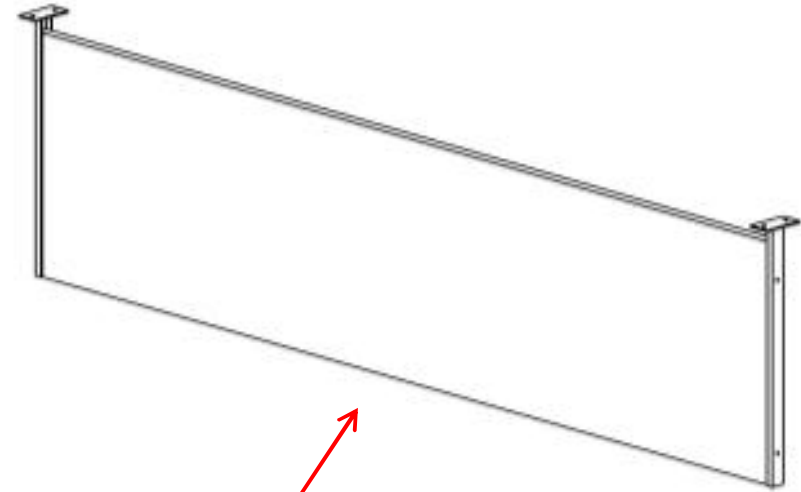

**Modesty Panel ( Chipboard Panel )**



**DE SPACE**  
OFFICE SYSTEM  
( SA 0091847-K )  
T : 016-260 3208 / 016-337 6818  
F : 03-5634 8332 / 03-8062 1098  
W : www.despaceoffice.com  
**This Drawing is Copyrighted.**



**Office Furniture ( Meeting Table )**

**\* OPTIONAL ITEMS**



**Wire holder ( Silver colour )**



**Wire Management ( Metal ) ( Silver colour )**

300W x 50D x 725H mm



( SA 0091847-K )  
T : 016-260 3208 / 016-337 6818  
F : 03-5634 8332 / 03-8062 1098  
W : www.despaceoffice.com

**This Drawing is Copyrighted.**

**ACCESSORIES**



**Adjustable Keyboard Tray ( Metal )**



**Hanging CPU Holder ( Metal )**



**Mobile Chipboard CPU Holders ( Plastic )**



**Plastic Keyboard Tray**



**Mobile Chipboard CPU Holders ( Small & Big ) – Grey color**

**Hanging CPU Holder ( Chipboard )**  
**\* Without Wheels**



( SA 0091847-K )  
T : 016-260 3208 / 016-337 6818  
F : 03-5634 8332 / 03-8062 1098  
W : www.despaceoffice.com

**This Drawing is Copyrighted.**

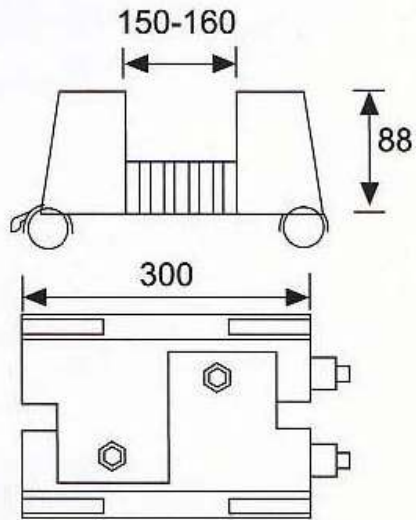

**Mobile CPU Holder ( Metal )**

**MCPU**

**\* Subject to stock availability**



T : 016-260 3208 / 016-337 6818  
F : 03-5634 8332 / 03-8062 1098  
W : www.despaceoffice.com

**This Drawing is Copyrighted.**

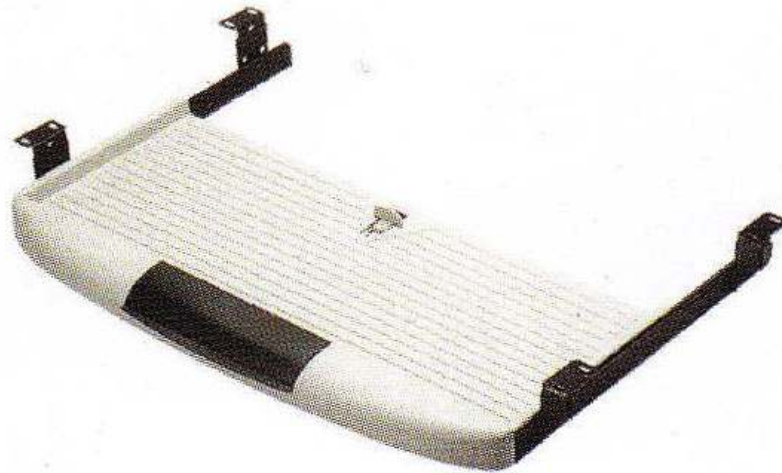

**Keyboard Tray  
T K516LG, BL**

**\* Plastic Type Sliding**

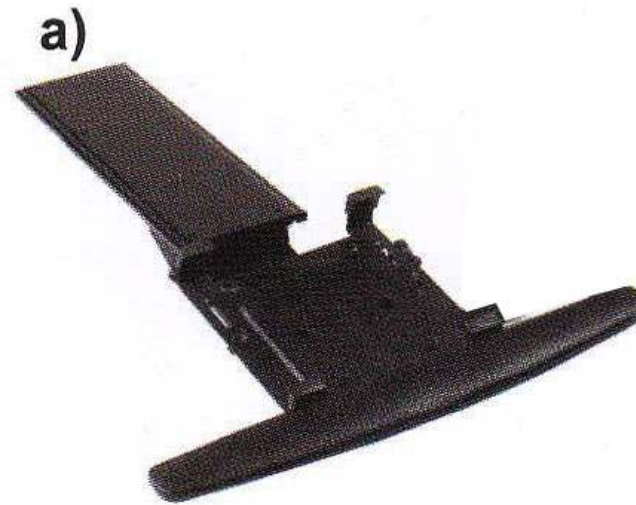

**Adjustable Keyboard Tray  
a) T MA 1002.BL**

**\* Metal Type \* Adjustable**

**\* Subject to stock availability**



(SA 0091847-K)

T : 016-260 3208 / 016-337 6818

F : 03-5634 8332 / 03-8062 1098

W : www.despaceoffice.com

**This Drawing is Copyrighted.**

**Other Accessories :-**

**\* OPTIONAL ITEMS**



**Add Computer Grommet Holes  
c/w cover (~35 / 59 / 80 mm Dia Holes )  
BEECH / MAPLE / CHERRY / LIGHT GREY color**



**Bottom View of Wooden Box**



**Flipper Cover + Bottom Wooden Box ( for wire socket )**

\* Electrical works / Wire socket / Points by others



**Wire holder**

**( Silver colour )**



T : 016-260 3208 / 016-337 6818  
F : 03-5634 8332 / 03-8062 1098  
W : www.despaceoffice.com

**This Drawing is Copyrighted.**